

# ***M20A.S***

## ***Modular Floodlight***



**- 1250W -**

Ongoing



# SPECIFICATION

## Product: M20A.S Modular Floodlight

Part No.: M20A1250S



1250W

### 1. Main features

- Cold forging pure aluminum with high thermal conductivity.
- Die-casting aluminum bracket for less weight.
- 3535 ceramic LED with low thermal resistance to enable very high reliability and long lifetime.
- 140-150lm/W based on sharp spill light control.
- Professional optical design, lens can be interchanged.
- Beam angle: 12°/30°/60° symmetric; 40°x15°/60°x15°/100°x17°/100°x60°/130°x25° asymmetric.
- 20KV surge protection.
- Driver box flexible for remote (only one 3-core cable).
- Inrush current limiter integrated.
- Thermal control unit integrated to protect LED module.
- G2.0 driver control board, minimize driver failure rate.
- Dali-2, 0/10V, DMX dimmable available.
- Angle fine tuning attainable precision 0.5°.

### 2. Product details

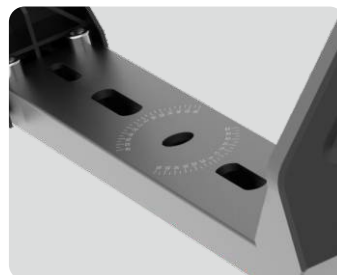
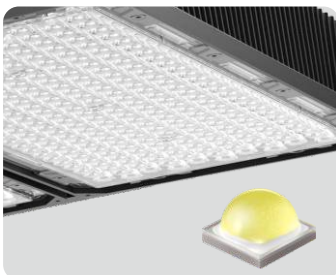

### 3. Dimensions (Unit: mm)

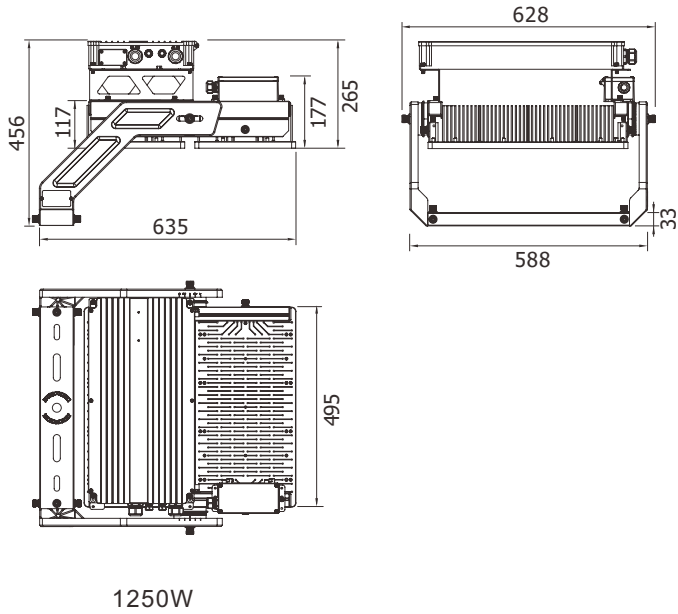

### Control Gear ( Driver Box )

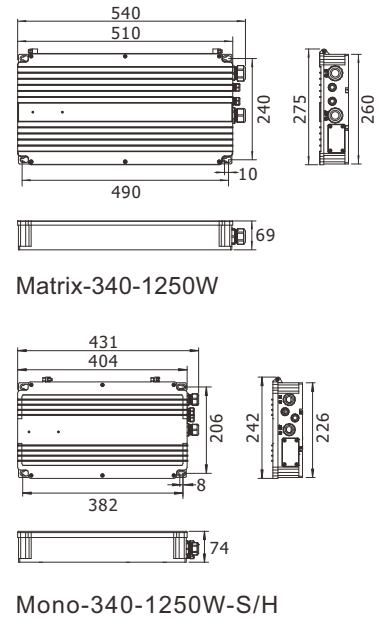

### 4. Technical data

Model No.	M20A1250S	Model No.	M20A1250S	
Light Source	SMD 3535	Beam Angle	12°/30°/60° symmetric; 40°x15°/60°x15° 100°x17°/100°x60°/130°x25° asymmetric	
Control Gear	Matrix/ Mono-S/ Mono-H	THD (230VAC)	<20%	
Input Voltage Range *	100-305Vac; 249-528Vac	50/60Hz	Surge Protection	20KV
LED Power (W)	1136-1218	Dimmable	0/10V; Dali-2; DMX	
System Power(W)	1208-1256	Housing Color	Black / Gray	
Luminous Flux(lm)	165,800-172,100	IP Class	IP66	
Power Factor	>0.95	Working Temperature (°C)	-20 to +50	
CCT (K)	3000/4000/5700	Working Humidity(RH%)	10-90	
CRI	>70 / >80	Power Cable	1m H07RN-F 3x1.5	
		Outer Carton(CM)	85.5*73*36(1pcs/CTN)	

\* Certified voltage range: Matrix/ Mono-S(100-240Vac); Mono-H(277-480VacC)

### 5. Net Weight

Model No.	Luminaire	Control Gear			
		Matrix(0/10V)	Mono-S(0/10V)	Mono-H(0/10V)	Matrix(Dali)
M20A1250S	15.8 Kg	7.1 Kg	6.8 Kg	7.4 Kg	8.3 Kg

## 6. Luminous intensity distribution diagram

For the IES file, please contact us by E-mail.

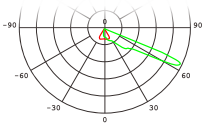

40°x15° Asy

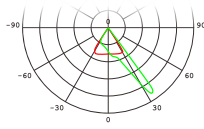

60°x15° Asy

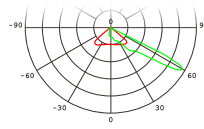

100°x17° Asy

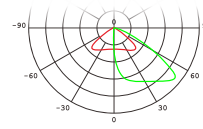

100°x60° Asy

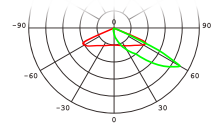

130°x25° Asy

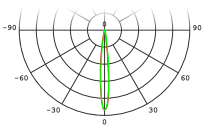

12°

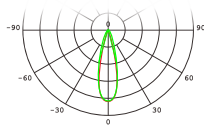

30°

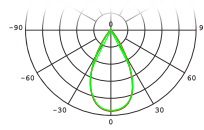

60°

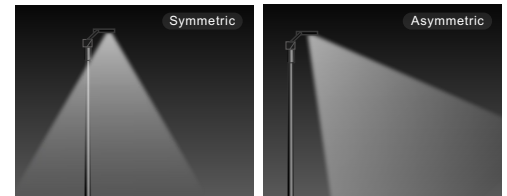

## 7. Innovations

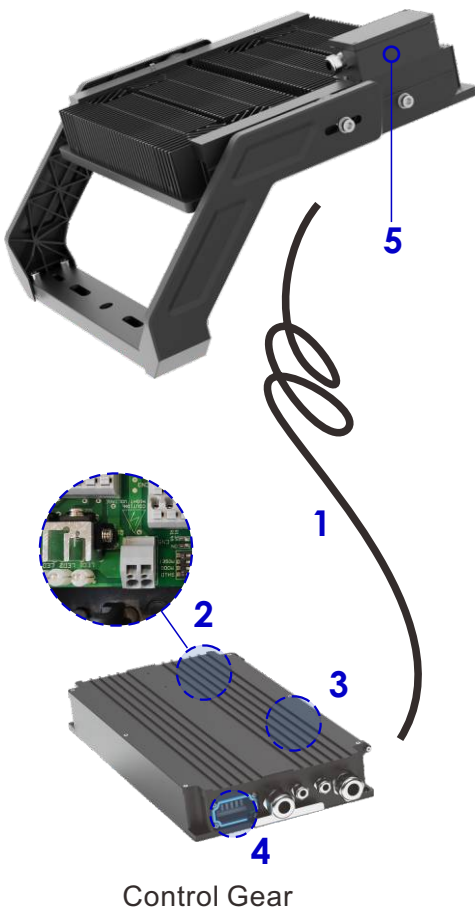

Control Gear

- 1** Only one 3-core cable go up to the luminaire  
Cost-saving, easy connect
- 2** Super high reliability:  
Multiple isolated drivers inside with the second generation driver control board.
- 3** 20KV surge protection
- 4** Transparent PC window for monitors/Bluetooth signals
- 5** Thermal Control Unit  
To protect LEDs from extreme condition

## 8. Wiring of separated control gear solution



### (1) Connection of luminaire

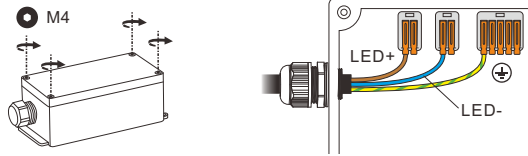

### Cable gland of Matrix & Mono

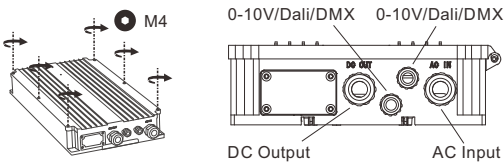

Connection	Cable Gland	Toque (N*m)	Cable Diameter (mm)	Cable Section (mm <sup>2</sup> )
AC Input	M20	5.5	8-10/10-12	1.5/2.5
DC Output	M20	5.5	8-10/10-12	1.5/2.5
Dimmable	M16	2.5	7-10	1.0-1.5

### (2) Matrix (0-10V / Dali)

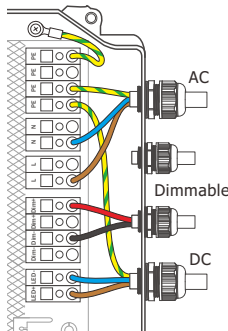

### (3) Mono-S (0-10V / Dali)

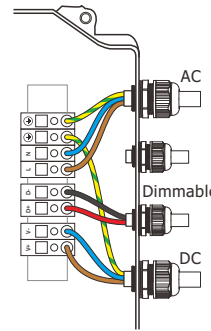

### (4) Mono-H (0-10V / Dali)

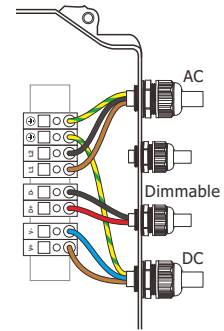

**Note:** According to the actual needs, the number of connectors will increase or decrease.  
Different dimming function cannot be used at the same time.

## 9. Installation



- For details, please refer to Installation Instruction.
- Installation must be performed by qualified person.
- Disconnect before installation.
- Installation tools are not provided.

### Mounting bracket

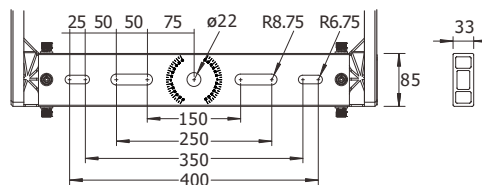

### Selection of mounting holes

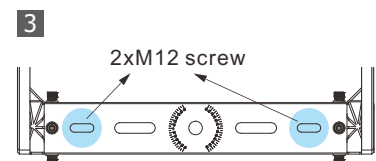
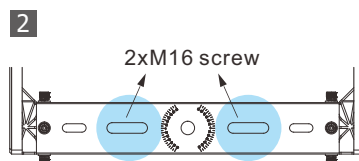
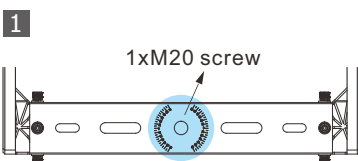

## Position allowed

This Modular floodlight can be installed on pole, wall, ceiling or on a horizontal surface.

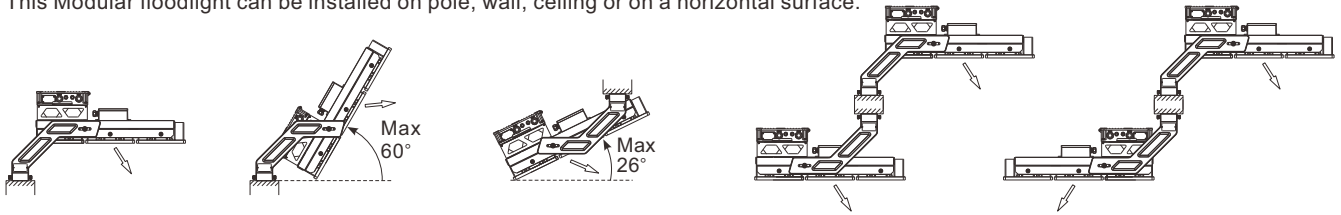

## Position not allowed

**Note:** Considering the heat dissipation, load bearing and dust accumulation, some installation methods are not allowed.

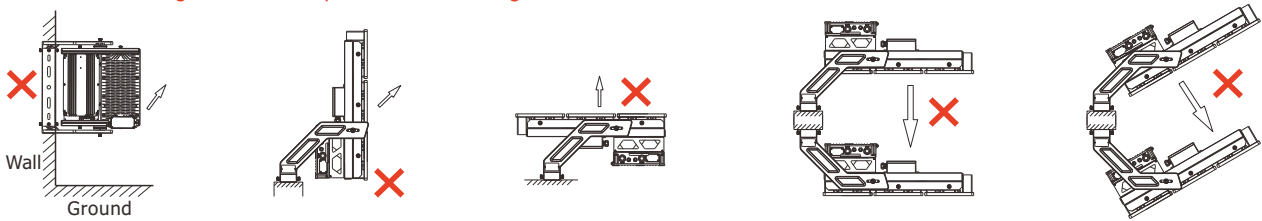

## 10. Effective Projected Area (EPA=SCx)

Unit: m<sup>2</sup>

Power \ Tilt angle	0°	10°	20°	30°	45°	60°
1250W	0.08	0.09	0.10	0.13	0.15	0.18

## 11. Application

Suitable for football stadiums, tennis courts, stadiums and other large sports venues, high mast, harbor, airport, warehouse, workshop, gas stations, toll stations, parking area, etc.

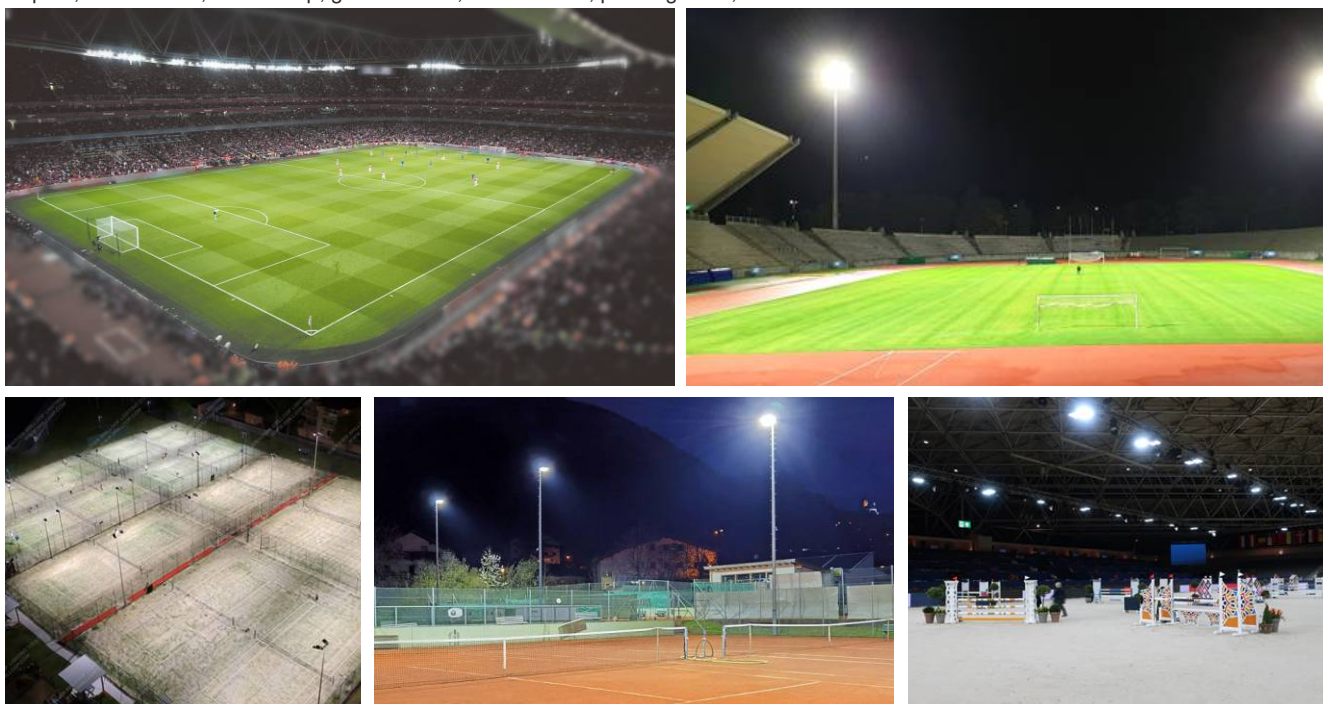

## Revision History

Version	Change Date	Description of change
1.3	14-Aug-23	The installation drawing has been modified.
1.4	23-Aug-23	According to the IES test data, the power and luminous flux are modified.
1.5	4-Aug-23	The dimension of Matrix was modified; Added driver separation solution and EPA information.
2.0	13-Sept-23	The information of separated control gear solution was modified.
2.1	19-Sept-23	Added the text: 3535 ceramic LED, and added the picture of the LED
3.0	1-Nov-23	Updated the dimension of products; Deleted the beam angle: 90°x15°; Added the beam angle: 130°x25°
3.1	14-Nov-23	The FCC certification icon was removed, and the light distribution diagram of 130°x25° was modified.
3.2	21-Nov-23	The wiring diagram of Mono has been modified